

*Report on the Suitability of Class 6,
U.S. Government Security Repositories
for the Storage of Small Quantities
of High Explosives*

Los Alamos
NATIONAL LABORATORY

*Los Alamos National Laboratory is operated by the University of California
for the United States Department of Energy under contract W-7405-ENG-36.*

An Affirmative Action/Equal Opportunity Employer

This report was prepared as an account of work sponsored by an agency of the United States Government. Neither The Regents of the University of California, the United States Government nor any agency thereof, nor any of their employees, makes any warranty, express or implied, or assumes any legal liability or responsibility for the accuracy, completeness, or usefulness of any information, apparatus, product, or process disclosed, or represents that its use would not infringe privately owned rights. Reference herein to any specific commercial product, process, or service by trade name, trademark, manufacturer, or otherwise, does not necessarily constitute or imply its endorsement, recommendation, or favoring by The Regents of the University of California, the United States Government, or any agency thereof. The views and opinions of authors expressed herein do not necessarily state or reflect those of The Regents of the University of California, the United States Government, or any agency thereof. Los Alamos National Laboratory strongly supports academic freedom and a researcher's right to publish; as an institution, however, the Laboratory does not endorse the viewpoint of a publication or guarantee its technical correctness.

*Report on the Suitability of Class 6,
U.S. Government Security Repositories
for the Storage of Small Quantities
of High Explosives*

*Herbert H. Harry
Donald Murk*

**REPORT ON THE SUITABILITY OF CLASS 6, U. S. GOVERNMENT
SECURITY REPOSITORIES FOR THE STORAGE OF SMALL
QUANTITIES OF HIGH EXPLOSIVES**

by

Herbert H. Harry and Donald Murk

ABSTRACT

The Explosives Review Committee initiated a study into the safety aspects of the common practice of storing small amounts of HE in safes. Although storage of HE (<10 grams) in older asbestos-lined safes was permitted, the newer style Class 6 Security safes are an unacceptable repository for even very small amounts of HE without the use of a blast-mitigating insert .

INTRODUCTION

The Explosives Review Committee (ERC) of the Los Alamos National Laboratory has undertaken an experimental review of storage of small quantities (<10 grams per drawer) of high explosives in security repositories (Class 6, Two-Drawer, U. S. Government Security Containers). This practice has become commonplace within this Laboratory, and it is finding its way into private industry and universities throughout the country as interest in explosives research grows. Previous experiments of this kind were conducted at the Lawrence Livermore National Laboratory in the early 1960s. The results of this previous work, conducted using old Remington and Mosler safes with fire-resistant asbestos drawer linings and very strong construction were that amounts of explosives not exceeding 10 grams per drawer could be safely stored within these security repositories.

The advent of the Class 6, two-drawer safe has not dampened the enthusiasm for continued storage of explosives in such new repositories. Unfortunately, these new repositories do not have heavily lined drawers and are not of substantial construction. A series of experiments is described in the remainder of this document. These experiments impulsively loaded the inside of the repository to roughly 200 psi. It is clear that under these conditions the use of such repositories is utterly unsatisfactory for safety from blast and fragments in the event of an unintentional initiation of 10 grams of explosive. This form of storage poses an especially grave threat if the explosive happens to be stored in the bottom drawer of such a two-drawer safe.

We have developed a drawer liner in the form of a laminated Lexan, foam, plywood box that will withstand the blast and contain the fragments from up to 10 grams of high explosives. This liner will fit into the drawer of any existing safe. The liner will provide blast and fragment protection, and the safe will provide security protection.

EXPERIMENTS

In January 1998, two experiments were conducted to determine if the blast from small amounts of HE could be safely contained in a two-drawer security safe. The two safes, one Art Metal and the other Mosler, were both the Class 6, Two-Drawer, U. S. Government Security Containers commonly found throughout the Laboratory. Both were of similar construction being about 20 in. wide, 28 in. tall, and 28 in. deep with 20-gauge steel drawers and a 1/8-in. steel outer shell (Fig. 1).

Both tests involved placing 11.8 grams of PBX 9501 in the center of the drawer to be tested and detonating the HE with a very small detonator producing very little shrapnel and containing 0.1 gram HE. The HE was placed about 4 in. from the floor of the drawer and facing the front (Fig. 2).

In test number 1, the HE was placed in the top drawer. The safe was closed, the bolts engaged and the combination dial spun. After detonation, the top drawer was found to be bowed out in the middle and open about 1 1/4 in. (Fig. 3). The bolts held the drawer from opening further, but the bowing (about 15 deg) had nearly caused the bolts to become disengaged (Fig. 4). The top and both sides of the safe were bowed outward approximately 3/4 in. The bottom drawer was also opened about 1 1/4 in. and the drawer pull broken off. It was found about 8 feet in front of the safe. The combination mechanism was still operable, but the handle on the opening mechanism would not withdraw the bolts; therefore, neither drawer could be opened. Entry to the top drawer was gained by prying the drawer front off and the bolts from behind the retainers. Extensive damage to the top drawer was found in the form of bulging the 20-gauge steel outward against the outer shell and downward into the lower drawer space (Fig. 5).

In test number 2, an identical charge was placed in the center of the bottom drawer, also about 4 in. from the bottom. The combination mechanism and the wedge, which holds the bolts in a locked position, had been removed. The safe was closed and the bolts engaged. After detonation (Fig. 6), the 20-gauge inner liner of the bottom drawer was found 95 feet from the front of the safe. The outer 1/8-in.-thick drawer face weighing 3.35 kilograms was found 52 feet away after having skipped hard twice against the frozen soil (Fig. 7). Some of the welds securing the 1/8-in.-thick safe top had broken allowing it to rise up about 1/2 in. (Fig. 8). The center cross brace between the two drawers was not protected from the blast by the 20-gauge drawer material as in test number 1, and the welds with the sides were broken. This allowed the sides to bulge out enough to allow the left-hand bolt on the top drawer to disengage past its retainer (Fig. 9), and the top drawer was found open about 2 1/2 in. The top drawer was rendered inoperable. The rear of the safe was bulged out about 3 in.

DRAWER INSERT

A container designed to mitigate HE blast effects was tested in the bottom drawer of a Mosler two-drawer safe. It consisted of a 14-in. square by 9 1/4-in.-tall box of 1 1/8-in. Lexan that is lined top, bottom, and sides with 1-in. Styrofoam and a 1/2-in. layer of plywood. A 1/4-in. gap around the top and a 1/10-in. gap around the bottom were provided for gas relief. Two 1/4 in. × 2 in. steel bars passed through slots in steel "U" straps were used as the container closure. The usable storage volume inside the container is 8 3/4 in. × 8 3/4 in. × 2 5/8 in. (see Figs. 10 and 11).

A 12.0-gram charge of C4 explosive was placed in the bottom center of the container (Fig. 12), the lid secured with the steel straps (Fig. 13), and the safe closed and locked.

After detonation of the charge, the safe was examined and found to have no outward signs of damage (Fig. 14). The combination and latch mechanisms functioned properly, and the safe was opened. The bottom drawer opened, and only a small outward bow to the inside drawer front was observed. The steel straps on the lid of the container were bowed up about an inch, but the Lexan container showed little or no damage (Fig. 15). The inside layers of Styrofoam and plywood were heavily damaged from the heat and pressure of the blast (Fig. 16). The bottom of the top drawer was bulged up and the sides bowed inward (Fig. 17), but the drawer was operational. We were unable to close the top drawer again until the bow in the bottom was pushed back down.

This insert is relatively inexpensive to have fabricated—\$600 to \$1,000 per insert—and is easily managed inside the drawer. In addition, the storage space in the insert can be fitted with a container of rigid foam that is machined to hold sample vials that would provide additional protection in the event of a rapid release of explosive energy within a given vial.

CONCLUSIONS

From the experiments described above it is clear that consolidated charges of 10 grams of high explosives may not be safely stored in the current Class 6 Security Containers found within the laboratory. Thus, it is the responsibility of each employee to ensure that no such storage occurs. Nonpropagating arrays for smaller charges and the use of the newly designed drawer liner are mandatory in order to continue use of the Class 6 Safe for storage of up to 10 grams of explosives. ***Finally, a number of us have heard the rumor that these safes are all right for the storage of up to 25 grams of explosives per drawer. THIS IS ABSOLUTELY NOT TRUE. DO NOT DO IT. DO NOT EVEN THINK ABOUT DOING IT (even with an insert!).***

ACKNOWLEDGMENTS

In our continual efforts to ensure the safety of our explosives operations, we wish to thank the DX-Division Office for the financial support the ERC needed to procure, destroy, and write about the Class 6 safes consumed in this study. In addition, we wish to thank DX-Division Office for the design and testing of the drawer liners.



FIGURE 1





FIGURE 3

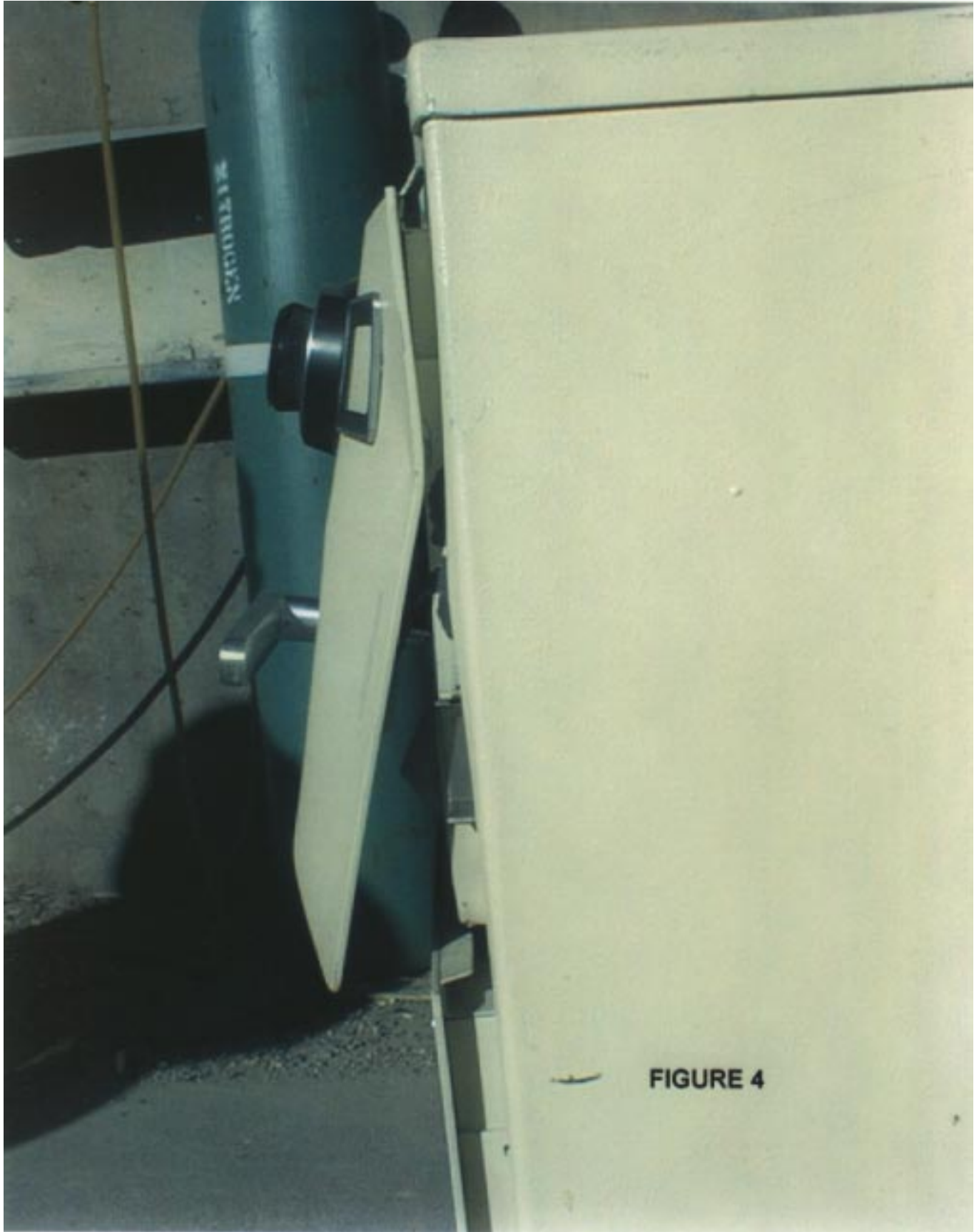


FIGURE 4



FIGURE 5

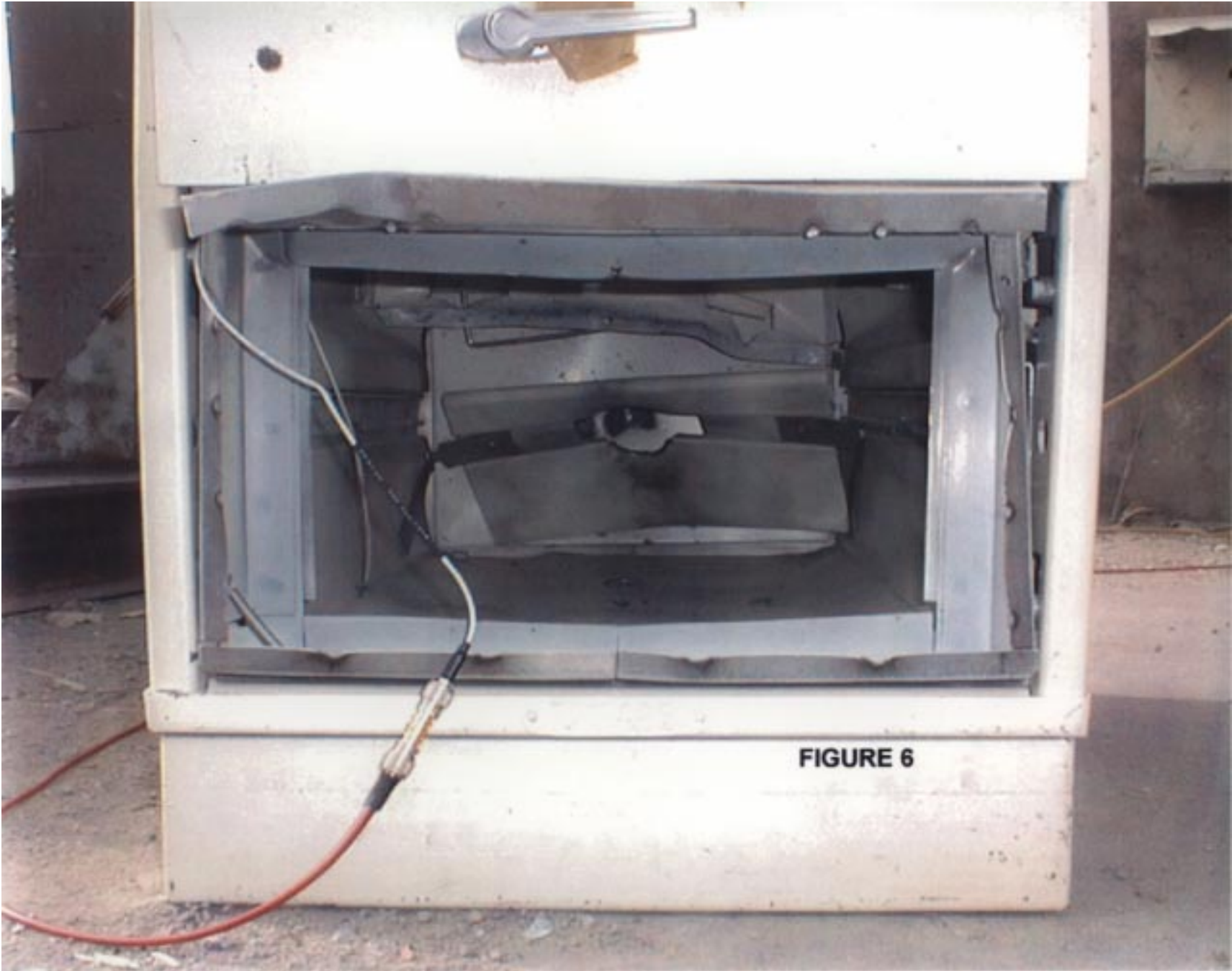


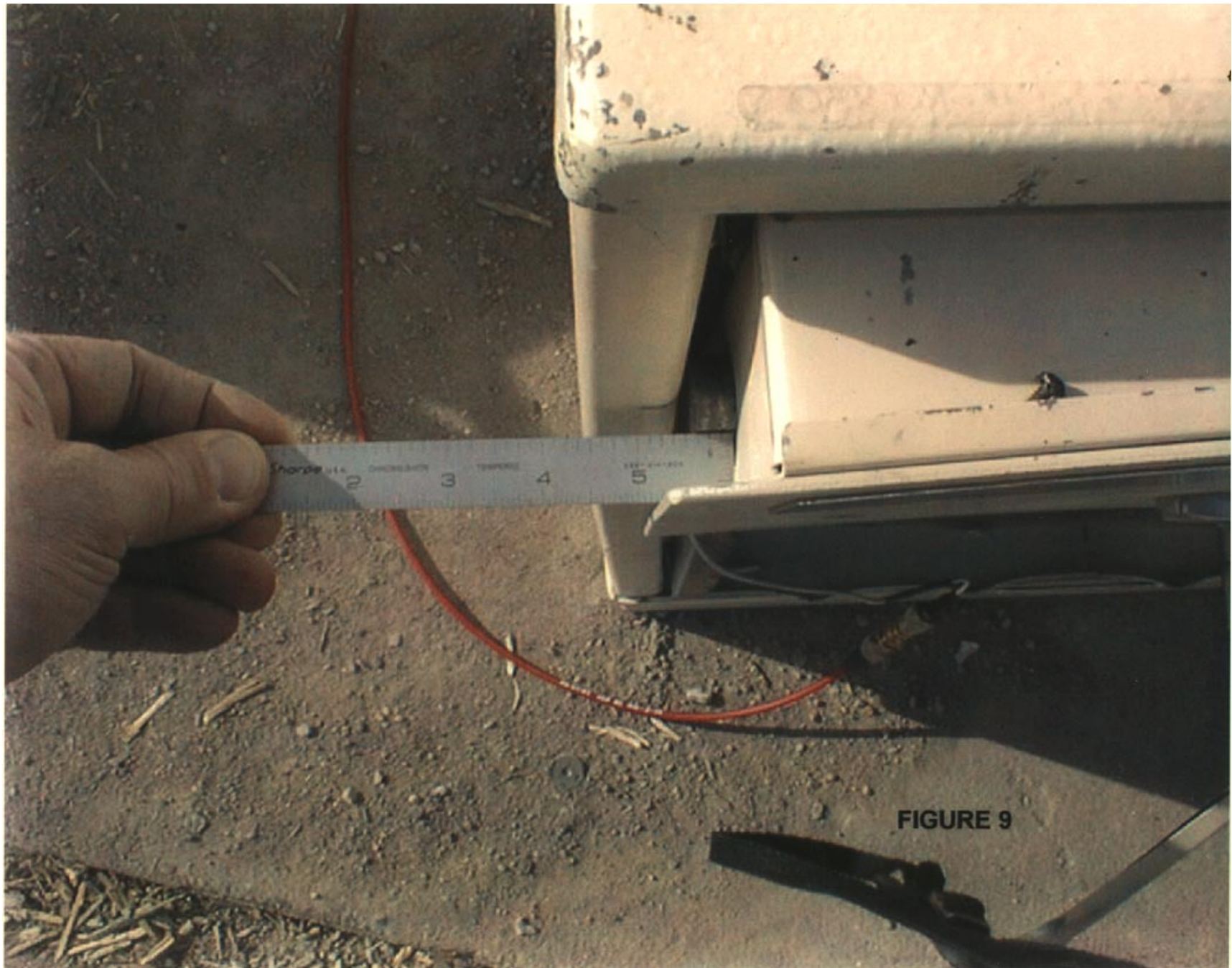
FIGURE 6

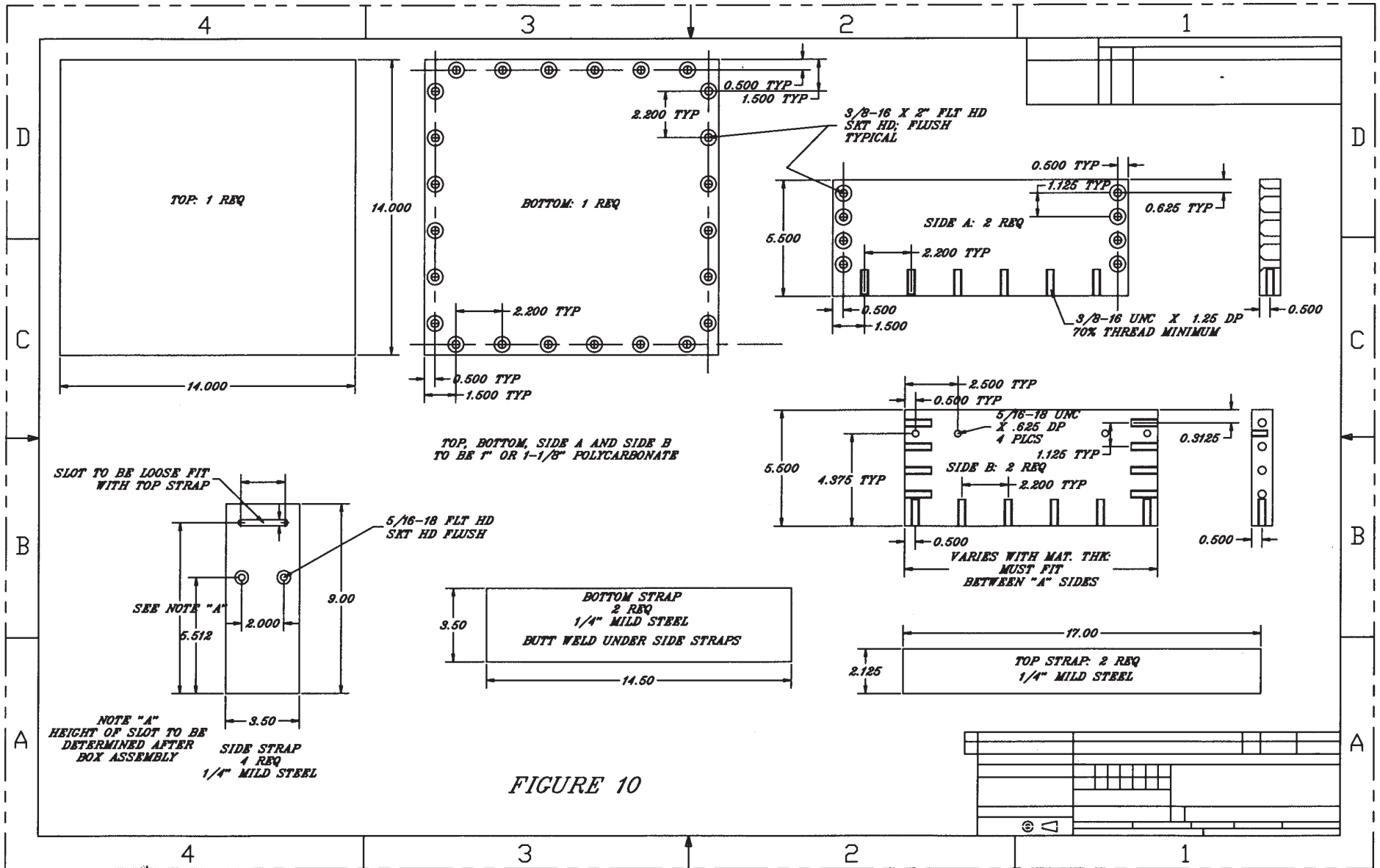


FIGURE 7



FIGURE 8





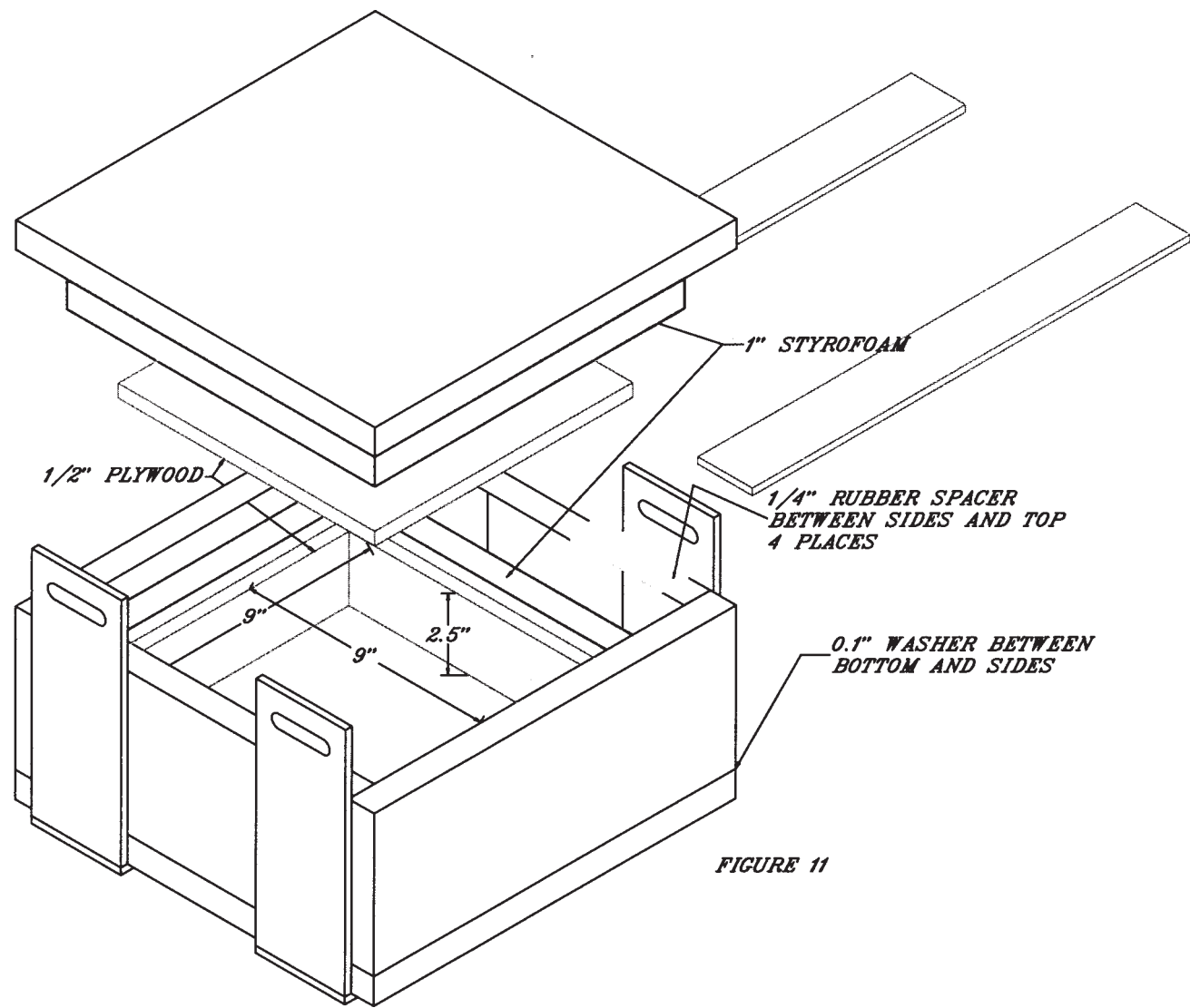


FIGURE 11

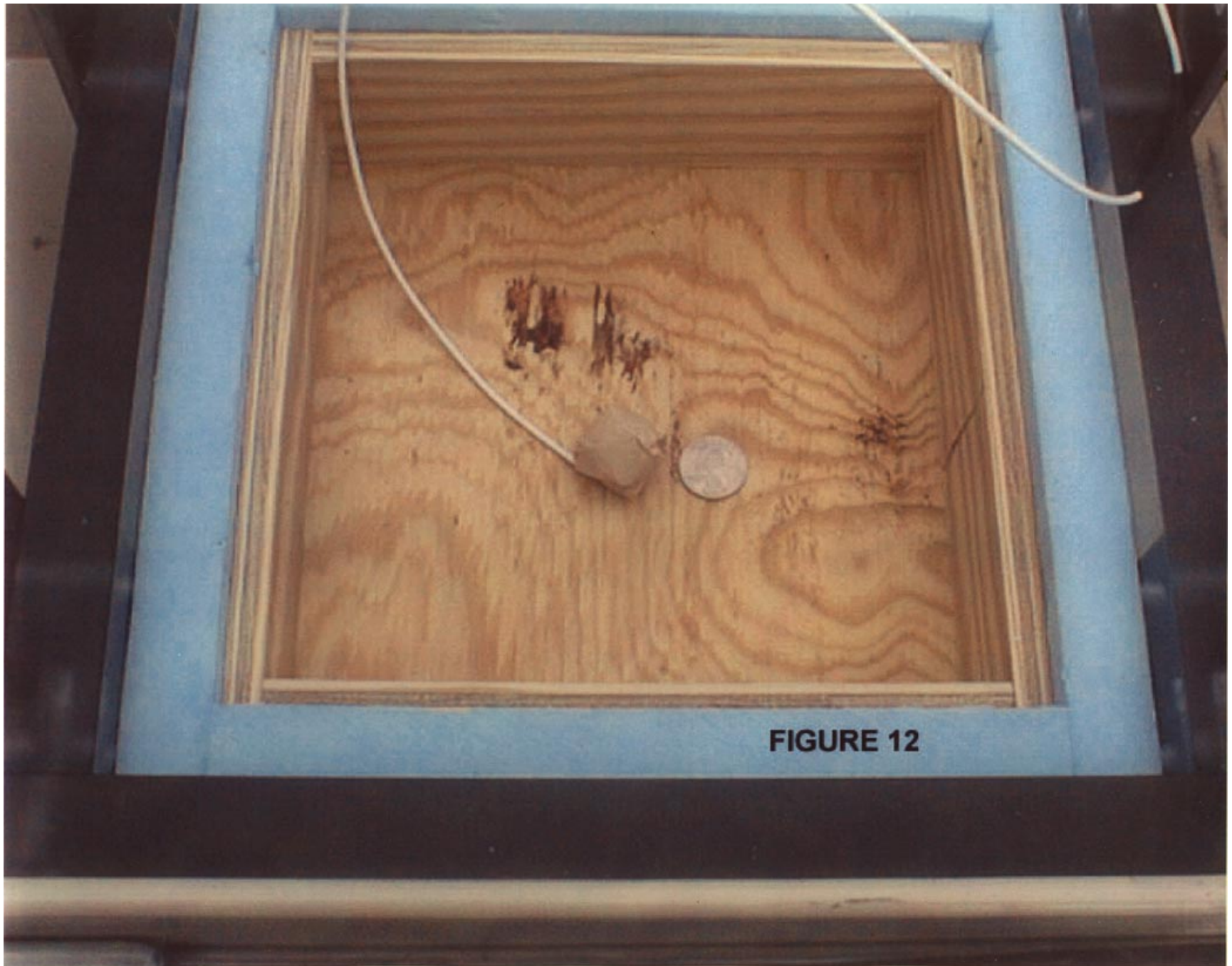


FIGURE 12





FIGURE 14



FIGURE 15



FIGURE 16

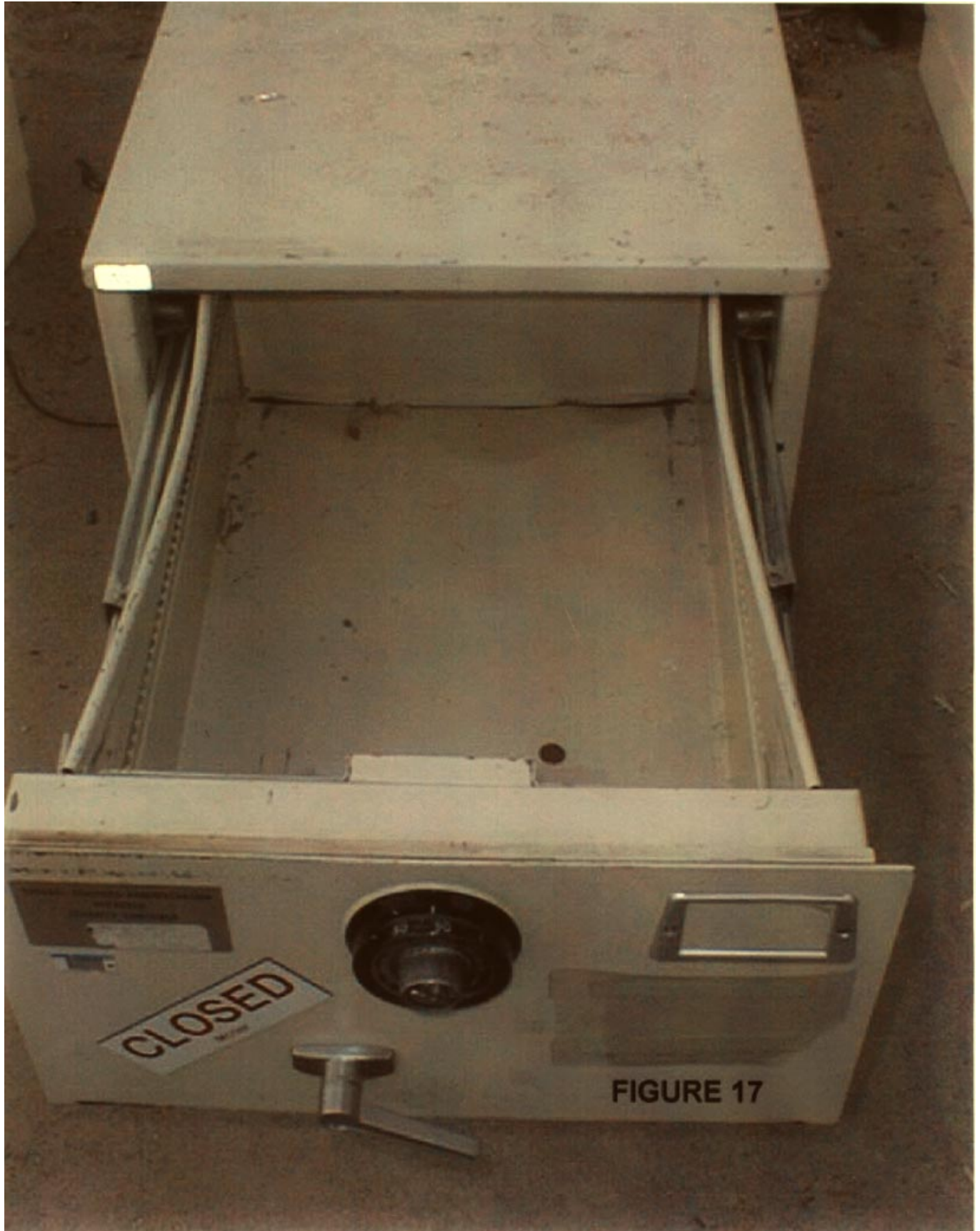


FIGURE 17

This report has been reproduced directly from the best available copy.

It is available to DOE and DOE contractors from the Office of Scientific and Technical Information, P.O. Box 62, Oak Ridge, TN 37831. Prices are available from (615) 576-8401.

It is available to the public from the National Technical Information Service, US Department of Commerce, 5285 Port Royal Rd., Springfield, VA 22616.

Los Alamos

NATIONAL LABORATORY

Los Alamos, New Mexico 87545